

ALINCO

VHF/UHF FM TRANSCEIVERS

**DR-110T/E, 112T/E/EM,
410T/E**

INSTRUCTION MANUAL

ALINCO ELECTRONICS INC.

20705 S. Western Ave., Suite 104, Torrance Ca. 90501, U.S.A.
Phone: (213) 618-8616

1-1-1 Mishimae, Takatsuki city, Osaka 569. Japan



DR-110T

ALINCO ELECTRONICS INC.

TABLE OF CONTENTS

Introduction	pg. 2
Accessories	pg. 2
Specifications	pg. 3
Operation	pg. 4
Control Functions	pg. 4
Function Operation	pg. 8
Scan	pg. 10
Priority Scan	pg. 11
Tone Frequency Selection	pg. 12
Tone Squelch (CTCSS)	pg. 14
Repeater Operation	pg. 13
Reverse Function	pg. 13
Transmission	pg. 14
Installation	pg. 15

INTRODUCTION

Congratulation, now you are the owner of one of our many "ALINCO" products. Your DR-110T/E, DR-112T/E/EM, 410T/E has been manufactured and tested very carefully at the factory and will give you satisfactory operation for many years.

ACCESSORIES

Carefully unpack your transceiver and you will find the following accessories included with the transceiver.

●Microphone	×1
●D.C. Power Cord	×1
●Spare fuse (8A)	×2
●Installing angle joint	×1
●M5×20 mm Screw	×4
●M5×20 mm Mounting Screw	×4
●M5 Nut	×4
●M5 Flat Washer	×4
●M5 Spring Washer	×4
●Screws for Bracket	×4
●M4×14 mm Screw	×4
●Rubber Support	×2

SPECIFICATIONS

■ General

Frequency Coverage	144.0~148.0 MHz (DR-110T, DR-112T) 144.0~146.0 MHz (DR-110E, DR-112E/EM) 440.0~450.0 MHz (DR-410T) 430.0~440.0 MHz (DR-410E)
Antenna Impedance	50 ohms unbalanced
Power Supply Requirement	13.8 Volts D.C.
Current Drain at 13.8 V	Receiving abt. 0.5 A Transmitting abt. 9.5 A (Hi) (DR-112EM: abt 5 A) abt. 4.0 A (Lo)
Dimension	140 mm (W)×40 mm (H)×170 mm (D) (5½"×2"×6¾")
Weight	Approx. 1.1 kgs. (2.64 lbs.)

■ Transmitter

Output Power	High; 45 Watts (VHF), DR-112EM; 25 Watts, 35 Watts (UHF) Low; Approx. 5 Watts
Emission Mode	16F3
Modulation System	Variable Reactance F.M.
Max. Frequency Deviation ..	±5 kHz
Spurious Emission	60 dB below carrier
Microphone	Electret Condenser Microphone
Operating Mode	Simplex Duplex ±600 kHz, 1.6 MHz, 5 MHz, 7.6 MHz or odd splits from receive frequency
DTMF Encoder	Built-in (U.S. Version)

■ Receiver

Receiving System	Superhetrodyne, dual conversion
Modulation Acceptance	16F3
Intermediate Frequency	10.7 MHz/455 kHz (VHF) 30.825 MHz/455 kHz (UHF)
Sensitivity	12 dB SINAD less than 0.16 μ V
Selectivity	More than ±6 kHz at -6 dB Less than ±12 kHz at -60 dB
Audio Power Output	abt. 2 W (8 ohms-10% Distortion)
Speaker Impedance	8 ohms

*Subject to change without notice.

OPERATION

CONTROL FUNCTIONS

Front Panel

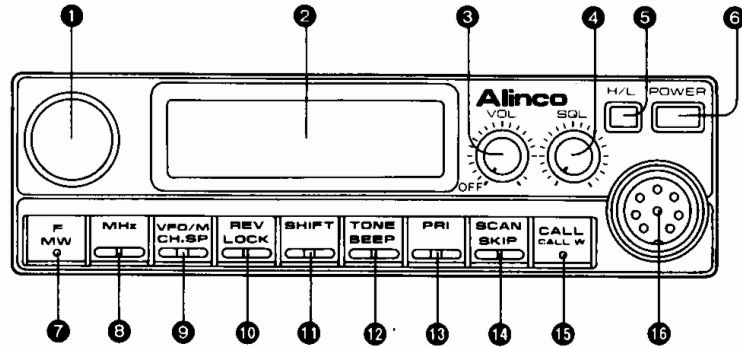

1 Main Dial

Main dial is used to select the transmit/receive frequency, Memory Channel, Frequency Step, Tone Frequency, and Offset Frequency.

2 Display Panel

The LCD displays operation information such as transmit/receive frequencies, memory channel informations, offset, tone frequency etc. See page 6 for additional information.

3 VOL (Volume) Control

Turn the control clockwise to increase the volume, and turn it counterclockwise to decrease the volume.

4 SQL (Squelch) Control

THE SQL control is used to eliminate noise during no signal periods. Normally this control is adjusted clockwise until the noise just disappears, and the BUSY indicator goes off. (Threshold level)

5 H/L (High/Low) Switch

This switch is used to select the desired transmitter output power level.

6 Power Switch

Press to turn on. Press again to turn off.

Function Keys (7 through 15)

NOTE: Commands underlined indicated in Blue on transceiver keys.

7 F (Function) Key

This is used to access secondary controlling function labeled in blue. i.e. MW, CH.SP, LOCK, BEEP, SKIP, and CALL W. See Function Operation pages 8–10.

MW is used with the F key to store data in memory. See Memory Pages 9–10.

8 MHz key

The MHz key is used to change the frequency up or down in one MHz steps.

Press the MHz key, and the decimal point and kHz digits will disappear from the display. The frequency in MHz will be changed by rotating the main dial or pressing the UP/DOWN buttons on the microphone. Press the MHz key again or the PTT switch to return the display to the complete frequency readout.

9 VFO/M (VFO/MEMORY) key

VFO/M is used to select VFO or Memory mode.

Press the VFO/M key to alternate between VFO and the Memory Channel mode.

CH.SP is used with the F key to select frequency steps for programming and scanning. See page 8.

10 REV (Reverse) key

REV is used to invert the TX and RX frequency in Repeater mode.

LOCK is used with the F key to disable the Function keys. See page 8.

SHIFT key

The SHIFT key is used to select the desired transmitter offset during repeater operation. When the key is pressed, the offset mode cycles from – to + to Dual to Simplex.

12 TONE key

(110E, 112E/EM, 410E: CTCSS key)

The TONE key is used to:

A. Activate the Tone frequency selection process. See page 12.

B. Enable/Disable the Encode/Decode functions. See page 12.

The BEEP key is used with the F key to Enable/Disable the function confirmation tone. See page 8.

13 PRI (Priority) key

The PRI key is used to control Priority function. See pages 11–12.

14 SCAN key

The SCAN key is used to activate the frequency scan and memory scan functions. See pages 10–11.

The SKIP key is used with the F key to skip busy memory frequencies when scanning. See page 8.

15 CALL key

(110E, 112E/EM, 410E: Tone Burst key)

The CALL key is used to bring Memory Channel “C” to the display. See page 9.

The CALL W is used to enter frequency into memory channel “C”. See page 9.

16 Microphone Connector

Plug the microphone into this jack.

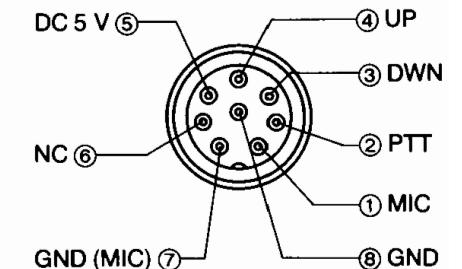

Display

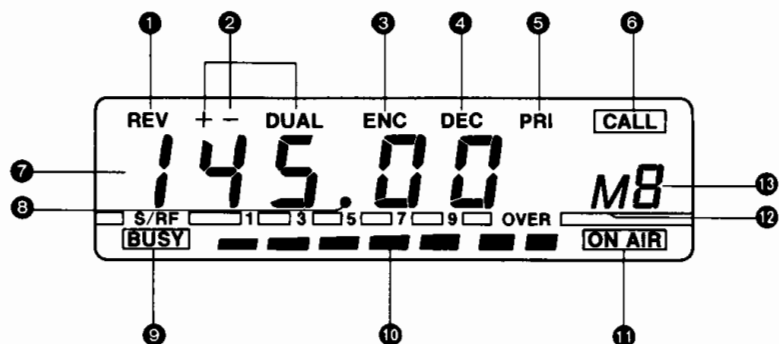

1 REV (Reverse) Indicator

Turns on when the reverse function has been selected.

2 Shift and Dual indicators

“+” or “-” indicator turns on during repeater offset operations. See page 13. “DUAL” indicator turns on during Dual operation. See page 14.

3 ENC (Encoder) indicator

Turns on to indicate that ENCODING TONE function is active.

4 DEC (Decoder) indicator

Turns on to indicate the DECODER (CTCSS) function is active.

5 PRI (Priority) Indicator

Turns on to indicate the PRIORITY function is active.

6 CALL Indicator

Turns on to indicate the CALL function is active.

7 Frequency display

Displays the transmit/receive frequency, Frequency Step, or Tone Frequency.

8 Decimal point indicator

Separates the MHz, and kHz. Flashes in Scan mode. Disappears in Memory skip mode.

9 BUSY indicator

On whenever the squelch is open or signal is received.

10 S/RF Meter

This meter indicates the relative receive input signal strength and relative transmitter RF output.

11 ON AIR indicator

Turns on during transmit operations.

12 M (Memory) indicator

Turns on whenever the transceiver is in the Memory mode. Flashes to indicate programming in process.

13 Memory Channel Number display

Indicates the selected memory Channel Number.

REAR PANEL

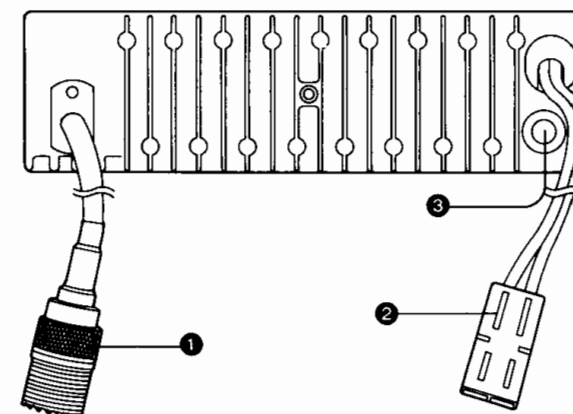

1 Antenna Connector

Used to connect the antenna to the set.
Use a PL259 antenna-plug with 50 Ohms impedance.

2 Power Connector

Connect the supplied power cable to this connector.

3 External Speaker Jack

When an external speaker (Imp.: 8 Ohms) is used, connect it to this jack.

FUNCTION Operation

Whenever the F key is pressed, the "M" indicator will flash. You must complete the desired programming within 5 seconds, or the indicator goes off or stops flashing. In that case, you must press the F key again.

The F key is used with secondary functions printed in blue on the transceiver function keys.

1. Frequency Step Selection

The frequency step can be selected by using the following procedure:

- Press the VFO/M key to select the VFO mode.
- Press the F key and then the CH.SP key.
- Select the desired frequency step using the Main Dial or the microphone UP/DOWN buttons. The example below shows the order, in which the Main Dial (or UP/DOWN buttons) will increase or decrease the spacing.

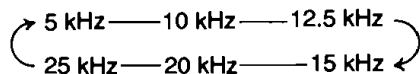

- Press the F key again or PTT switch to return to VFO mode.

2. Key Lock

- Press the F key, and then press the Lock key again.
- The "L" indicator will replace the Memory number shown on right side of display.
- Stops all function keys except the PTT switch.
- To cancel this function, press the F key and the LOCK key again.

3. BEEP ON/OFF

- Press the F key, and then press the BEEP key.
- Repeating this procedure, beep will turn ON and OFF alternately.

4. Memory Skip

The Memory Channel Skip function allows you to temporarily skip unwanted Memory Channels during Memory Channel Scanning.

- Press the VFO/M key to select the Memory Channel mode.
- Select the Memory Channel that you want to skip using the Main Dial or the microphone UP/DOWN buttons. Press F key, and then press the SKIP key. The decimal point between MHz and kHz will disappear from the display.
- A frequency in memory without the decimal point will be skipped when scanning memories.
- To cancel Memory Channel Skip, press the F key and the SKIP key again.

5. CALL Channel Entry

(DR-110T/112T/410T only)

- Select VFO mode by pressing the VFO/M key.
- Select the desired operating band and frequency.
- Press the F key, and then press the CALL W.
- When the CALL W is pressed, the frequency shown on the LCD will be stored into memory "C".
- Whenever CALL is pressed, Memory "C" will come to the display.
- To Change from CALL mode back to VFO or Memory, press the VFO/M key.

6. MEMORY

A lithium battery is installed to retain memory in the transceiver. Turning off the POWER switch, disconnecting power cable, or a power failure will not erase memory. The battery should last for approximately 5 years.

•Microprocessor Initialization

When you want to erase all programmed data, or if the display should show erroneous information, you should reset (initialize) the microprocessor using the following procedure:

- Press and hold the F key and the VFO/M key at same time, and turn off the POWER switch. Now turn the POWER switch on again, while still holding buttons depressed.
- Release the buttons—Factory programming is now in place.

•Memory Channel

This transceiver has 14 memory channels (1–9, A–E). In addition to serving as normal memory channels, some serve a dual purpose. The functions of the Memory Channels A–D are described below.

- Memory Channels A and B are used to store the Frequency limits for the Program Scan Function. For additional information, see Band Scan on page 11.
- Memory Channel C is used to store the CALL channel frequency.
- Memory Channel D is used to store the transmit frequency used for odd offset operation.

•Memory Channel Contents

Each Memory Channel is capable of storing:

Frequency
SHIFT status (Offset)
TONE status, (Encode, Decode, and Frequency)

Receive Frequency for odd offset operation. See page 14.

•Memory Entry

- Press the VFO/M key to select the VFO mode.
- Select the desired operating frequency.
- Activate sub audible tone if it is required.
- Press the F key. The "M" indicator will flash.

5. Select the desired Memory Channel using the Main Dial or the microphone UP/DOWN buttons.
6. Press the MW key during the "M" indicator is flashing. If the flashing stops before the MW key is pressed, you must press F key again in order to complete the desired function.

■ SCAN

The following scan options are available:

Program Scan (Limited Frequency Coverage in one band only)
Memory Scan
Band Scan

A. Programmable Scan

The scan frequency is determined by the frequencies stored in Memory Channels A and B.

The frequency stored in Memory Channel A and B must be different frequencies.

Before pressing the SCAN key, adjust the SQL control to the threshold level.

1. Determine the desired scan frequency range and enter the frequencies into Memory Channel A and B.
2. Press the VFO/M key to select the VFO mode, and also select the band of the stored frequencies.
3. Press the SCAN key to initiate scan.
4. To clear scanning, press the SCAN key or the microphone P.T.T. switch.

B. Memory Scan

1. Press the VFO/M key to select the Memory Channel mode.
2. Before pressing the SCAN key, adjust the SQL control to the threshold level.
3. Press the SCAN key to initiate scan.
4. To clear scanning, press the SCAN key or the microphone P.T.T. switch.

C. Band Scan

This scan will proceed over the entire tuning range of band.

1. Press the VFO/M key to select the VFO mode.
 2. Store the same frequencies into Memory Channels A and B.
 3. Before pressing the SCAN key, adjust the SQL control to the threshold level.
 4. Press the SCAN key to initiate scan.
 5. To clear scanning, press the SCAN key or the microphone P.T.T. switch.
- The transceiver will stop on a busy channel until a signal drops. After a short delay the scan will resume.
 - If you want to resume scanning when the transceiver stops on a busy channel, rotate the Main Dial or press the microphone UP/DOWN buttons.

■ PRIORITY SCAN

The following Priority Scan options are available:

Memory Priority Scan
VFO Priority Scan
CALL Priority Scan

A. Memory Priority Scan

1. Store the desired priority frequency into any Memory.
2. Select VFO mode, and dial up the frequency you want to operate on.
3. Press the PRI key to initiate Memory Priority Scan. The transceiver will scan the Priority in Memory Channel for 1 second out of 6 seconds and the VFO frequency for the remaining 5 seconds.
4. When a signal is present on the Priority Memory Channel, press the PRI key, and then press the VFO/M key. The Priority scan will stop and the Memory Channel will come to the display.

B. VFO Priority Scan

This function is the reverse of Memory Priority Scan.

1. Select VFO mode, and dial up the frequency to be scanned.
2. Select the desired Memory you want to operate on.
3. Press the PRI key to initiate VFO Priority Scan.
4. To cancel this scan, press the PRI key again.

C. CALL PRIORITY SCAN

1. Store the desired frequency for operation in Memory Channel "C".
2. Press the CALL key and then the PRI key.
3. The transceiver will scan the VFO for 1 second and the CALL Channel for 5 seconds alternately.

■ TONE FREQUENCY SELECTION

1. To select a Tone (CTCSS) Frequency, press the VFO/M key and select the VFO mode, then press the TONE key. The display will indicate a Tone Frequency in Hz.
2. Select the desired Tone Frequency using the microphone UP/DOWN buttons or the Main Dial.
3. This press also enables/disables Encode/Decode activation. There are 37 CTCSS Tone Frequencies available as shown below.
4. Press any key or the microphone PTT switch to return to the receiver frequency display. The subaudible tone will be transmitted whenever the PTT switch is depressed.

Subaudible Tone Chart

Hz	Hz	Hz	Hz	Hz	Hz
67.0	85.4	107.2	131.8	162.2	203.5
71.9	88.5	110.9	136.5	167.9	210.7
74.4	91.5	114.8	141.3	173.8	218.1
77.0	94.8	118.8	146.2	179.9	225.7
79.7	100.0	123.0	151.4	186.2	233.6
82.5	103.5	127.3	156.7	192.8	241.8
					250.3

■ TONE SQUELCH (CTCSS)

This function allows you to remain squelched until the proper Tone Frequency is received. If you are on a busy frequency, this can be quite an aid.

1. Press the TONE key. The "ENC" will appear on the display panel. Press the TONE key again. The "DEC" will appear next to the "ENC".
2. Your radio will now remain squelched until the proper code is received. You should ensure all stations, you wish to communicate with, use the same Tone Frequency.
3. To release the Tone Squelch function (Normal noise activate squelch), press the TONE key again. The "ENC" and "DEC" will disappear from the display.

■ REPEATER Operation

All amateur radio repeaters utilize a separate receiver and transmitter section. The receiver frequency may be either above or below the transmitter frequency.

This transceiver allows you to store the frequency, offset frequency (0.6, 1.6, 5.0 and 7.6 MHz.) and offset direction in Memory Channel (1-9 and A-E).

To select the desired transmitter offset direction, press the SHIFT key. Each time you press the key, the radio will advance from one offset to the other, i.e. "-" to "+" to "Dual".

To select the desired transmitter offset, press the SHIFT key, and then rotate the Main Dial or depress UP/DOWN button on the microphone. Each time you rotate or depress these controls,

the radio will advance through the following steps: "0" to "0.6" to "1.6" to "5" to "7.6". After the offset has been stored, press any key, except the SHIFT key, or depress the PTT switch. The normal display will return.

■ REVERSE Function

The REV key has been provided to allow you to reverse the transmit and receive frequencies. To use the Reverse function, press the REV key. The REV indicator will light in the display to remind you that you are working a reverse repeater pair.

To return to normal operation, press the REV key again.

TRANSMISSION

Caution

1. Ensure that an antenna with a low standing wave ratio (SWR) is attached to the antenna connector before attempting to transmit. Failure to provide proper termination may result in damage to the final amplifier section.
2. Always check to ensure the frequency is clear before transmitting.
6. Key the PTT switch and you will transmit on memory "d". Release it and you will receive on frequency displayed in VFO.

A. Simplex Operation

1. Select the desired operating frequency using any of the methods described above.
2. Press the microphone PTT switch. The ON AIR indicator will light.
3. Speak into the microphone. The recommended distance to the microphone is 2 inches (5 cm). Talking too far away may result in reports of weak audio.
4. Release the microphone PTT switch to return to the receive mode. The ON AIR indicator should go out.

B. Odd Offset Operation

—For other than 600 kHz, 1.6 MHz, 5.0 MHz and 7.6 MHz splits.

1. Select Memory "d" in memory mode.
2. Select VFO and dial up a transmit frequency required.
3. Press the F key then press the MW key to store the transmit frequency into memory "d".
4. While still in VFO mode dial up a receive frequency.
5. Press the SHIFT key to select offset, continue to press until transceiver cycles through +, - and Simplex to "Dual".

MOBILE INSTALLATION

1. Location

The transceiver may be installed in any position in your car, where the controls and microphone are easily accessible and safe operation of the vehicle or the performance of the set will not be interfered with. Refer to the diagrams for installation of the Mounting Bracket:

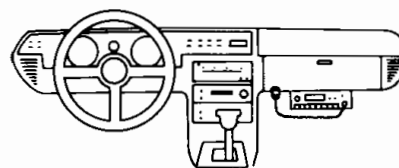

2. Power Requirements

The transceiver can be operated from any regulated 12 or 13.8 V negative ground source. For mobile use, power connections should be made directly to the battery to mini-mize the possible ignition noise pickup.

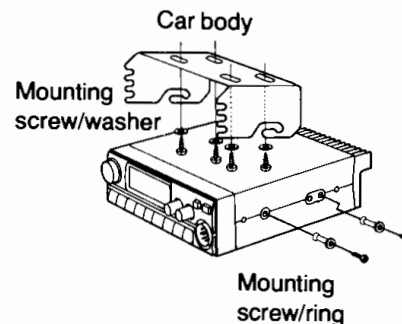
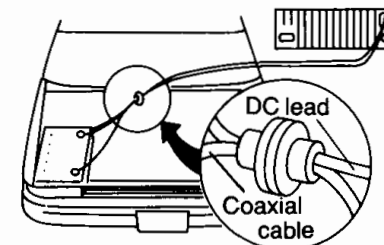

BASE STATION INSTALLATION

For fixed base operation, a 13.8 V D.C. Power Supply capable of providing at least 15 A continuously is required. Connect the red lead of the power cable to the Positive (+) terminal, and the black lead to the Negative (-) terminal of the D.C. Power Supply.

